

## SolarTech Power Solutions

# Communication base station battery energy storage system commissioning worker

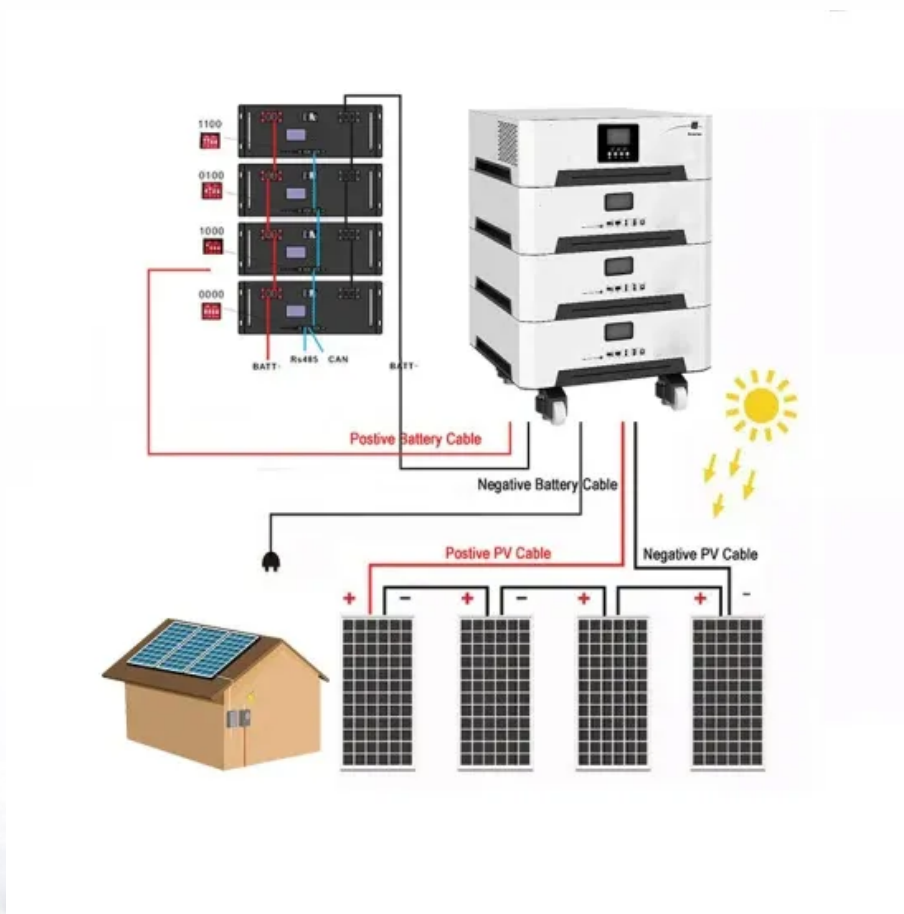

## Overview

---

What is Bess ion & energy and assets monitoring?

ion – and energy and assets monitoring – for a utility-scale battery energy storage system (BESS). It is intended to be used together with additional relevant documents provided in this package. The main goal is to support BESS system designers by showing an example desi.

What happens during energy storage project commissioning?

During energy storage project commissioning, every team involved feels the heat: For the EPC (Engineering Procurement and Construction) team, it's their final stretch of construction and they're eager to finish.

What is a battery energy storage system (BESS) e-book?

This document e-book aims to give an overview of the full process to specify, select, manufacture, test, ship and install a Battery Energy Storage System (BESS). The content listed in this document comes from Sinovoltaics' own BESS project experience and industry best practices.

What are the requirements for a battery management system (BMS) handover test?

Energy Storage Battery Management System (BMS) Handover Test The BMS single commissioning should meet the following requirements: BMS collects the battery voltage in real-time. BCU collects the terminal voltage of the battery pack in real-time.

What is a commissioning phase?

**COMMISSIONING** Commissioning phase is one of the most critical phases of the BESS' supply process. It marks the of- cial transition from a factory to a customer owned and operated BESS. "Commissioning helps ensure that a system was correctly designed, installed and tested.

How are battery energy storage systems transported?

Given the Battery Energy Storage System's dimensions, BESS are usually transported by sea to their destination country (if trucking is not an option), and then by truck to their destination site. A. Logistics The consequence is that the shipment process can be worrisome.

## Communication base station battery energy storage system commissioning

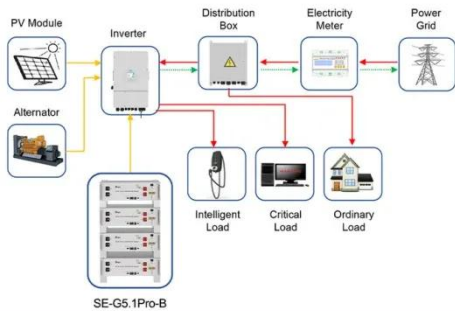

Application scenarios of energy storage battery products

### Installation and commissioning of energy storage for ...

The one-stop energy storage system for communication base stations is specially designed for base station energy storage. Deployment :Modular design enables quick disassembly and ...

### Communication Base Station Energy Storage Battery ...

Apr 3, 2025 · The communication base station energy storage battery market is experiencing robust growth, driven by the increasing demand for reliable and uninterrupted power supply for ...

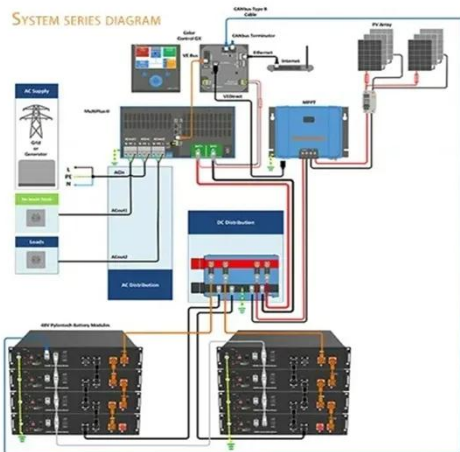

### Commissioning and Maintenance Processes for Energy Storage Systems

Nov 22, 2024 · As renewable energy continues to grow rapidly, energy storage systems are becoming an essential part of modern power systems. Proper commissioning and ...

## Commissioning and Maintenance Processes for Energy Storage Systems

Nov 22, 2024 · Proper commissioning and maintenance are critical to ensure these systems operate safely, reliably, and efficiently. Heres a detailed guide to the key processes involved in ...



## Strategy of 5G Base Station Energy Storage Participating in the Power

Mar 13, 2023 · The proportion of traditional frequency regulation units decreases as renewable energy increases, posing new challenges to the frequency stability of the power system. The ...

## Commissioning Engineer, Battery Energy Storage

Onsite for Commissioning and Acceptance Testing of Balance of Plant equipment including electrical systems such as, Switchgear, relay protection, metering, MV/LV transformers, and ...

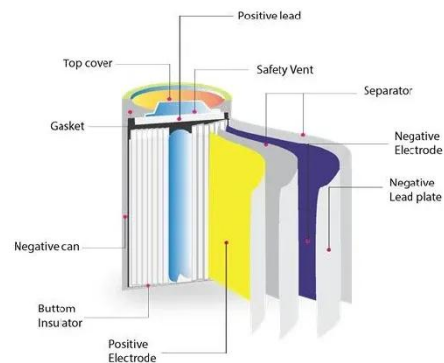

## Communication network cabinet system energy storage battery commissioning



Commissioning Manager - 5 years'' experience with renewable energy (Solar Utility Scale) and/or Energy Storage System, Power System Design, Communication Network, and minor ...

## Optimal configuration of 5G base station energy storage ...

Feb 1, 2022 · A multi-base station cooperative system composed of 5G acer stations was considered as the research object, and the outer goal was to maximize the net profit over the ...



## Communication Base Station Energy Storage , Huijue Group ...

Why Energy Storage Is the Missing Link in 5G Expansion? As global 5G deployments accelerate, operators face a paradoxical challenge: communication base station energy storage systems ...

## Energy storage system of communication base station

The Energy storage system of communication base station is a comprehensive solution designed for various critical infrastructure scenarios, including communication base stations, smart ...

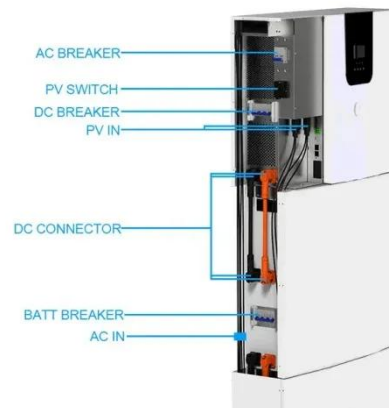

## EES Station Commissioning: Procedures & Safety ...

Oct 22, 2024 · Commissioning content includes testing battery array insulation resistance, cooling/heating systems, battery management system insulation ...

## Battery commissioning for energy storage power station

What is battery energy storage system (BESS)? You have full access to this open access article Battery energy storage system (BESS) is one of the effective technologies to deal with power ...



## The BESS System:

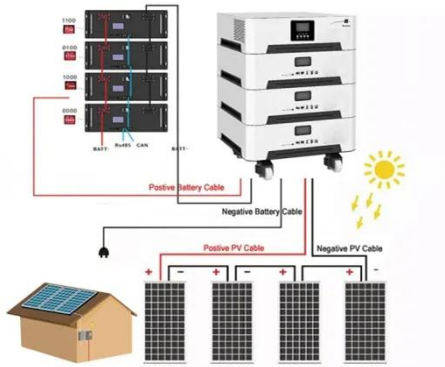

## Construction, Commissioning, and O& M

...

3 days ago · The energy storage inverter (PCS), battery management system (BMS), and energy management system (EMS) have powered up and completed single commissioning. ...

## Commissioning Energy Storage

Aug 27, 2019 · The value of commissioning is to insure proper operation of the energy storage system, safety systems, and ancillary systems. ALSO, Commissioning is an excellent means ...



- LIQUID/AIR COOLING
- INTELLIGENT INTEGRATION
- PROTECTION IP54/IP55
- BATTERY /6000 CYCLES



## Energy Storage in Telecom Base Stations: Innovations

With the relentless global expansion of 5G networks and the increasing demand for data, communication base stations face unprecedented challenges in ensuring uninterrupted power ...

## Communication Base Station Energy Storage Lithium Battery ...



Jun 30, 2025 · The future of the global communication base station energy storage lithium battery sales market looks promising with opportunities in the communication base station, hospital, ...

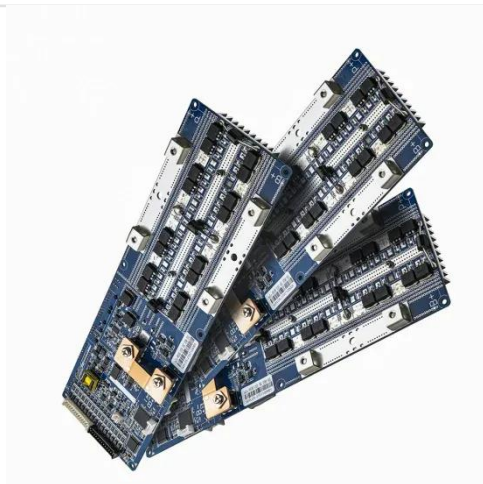
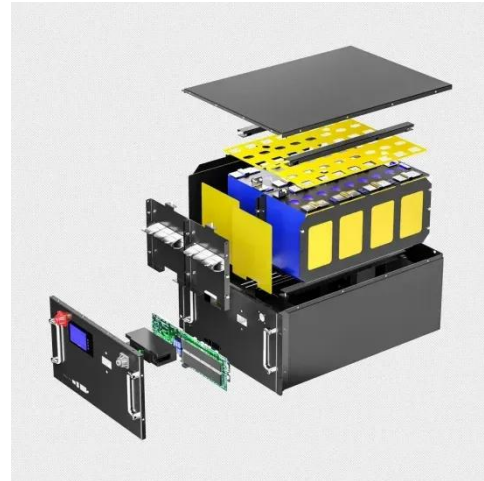

## BESS Commissioning: The Critical Pathway to Energy Storage ...

With global energy storage capacity projected to reach 1.6 TWh by 2030 (BloombergNEF), BESS commissioning emerges as the make-or-break phase determining project viability. Why do ...

## What is the purpose of batteries at telecom base ...

...

Feb 10, 2025 · The lead storage battery is the most widely used energy storage battery in the current communication power supply. Among the many types of ...

...



## Utility-scale battery energy storage system (BESS)



Mar 21, 2024 · Battery storage systems are emerging as one of the potential solutions to increase power system flexibility in the presence of variable energy resources, such as solar and wind, ...

---

## cairo communication base station energy storage battery ...

Lithium battery is the magic weapon for communication base station energy storage system and power container energy storage China's communication energy storage market has begun to ...



---

## Contact Us

For catalog requests, pricing, or partnerships, please visit:  
<https://posecard.eu>